

TRANSLUCENT PANELS

DM0001 - ALT. TRANSLUCENT PANEL SUPPORT DETAIL

DM0015 - TRANSLUCENT PANEL GENERAL NOTES

DM0020 - UNINSULATED (NON-UL90)

DM0022 - INSULATED (NON-UL90)

DM0023 - INSULATED (UL90 & FLORIDA APPROVED)

DM0024 - FACTORY BONDED (NON-UL90)

DM0025 - FACTORY BONDED (UL90 & FLORIDA APPROVED)

DM0026 - UNINSULATED (UL90 & FLORIDA APPROVED)

DM0001 - ALT. TRANSLUCENT PANEL SUPPORT DETAIL

[Download the DWG file by clicking here.](#)

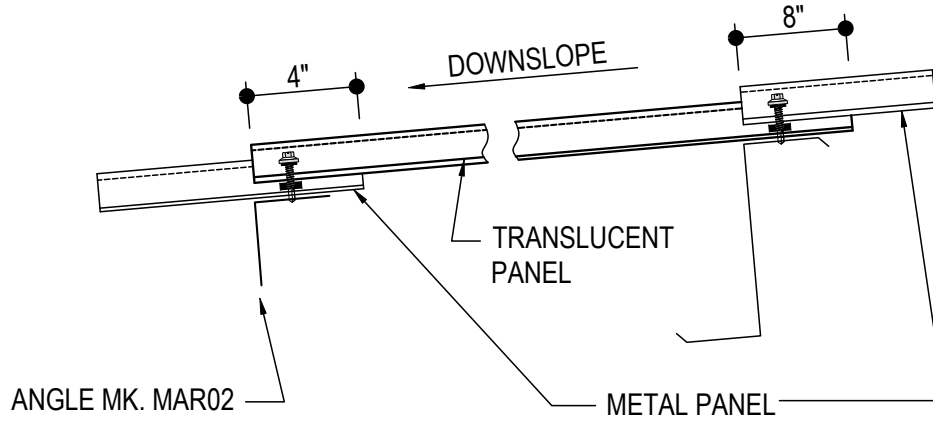

LAP DIMENSIONS

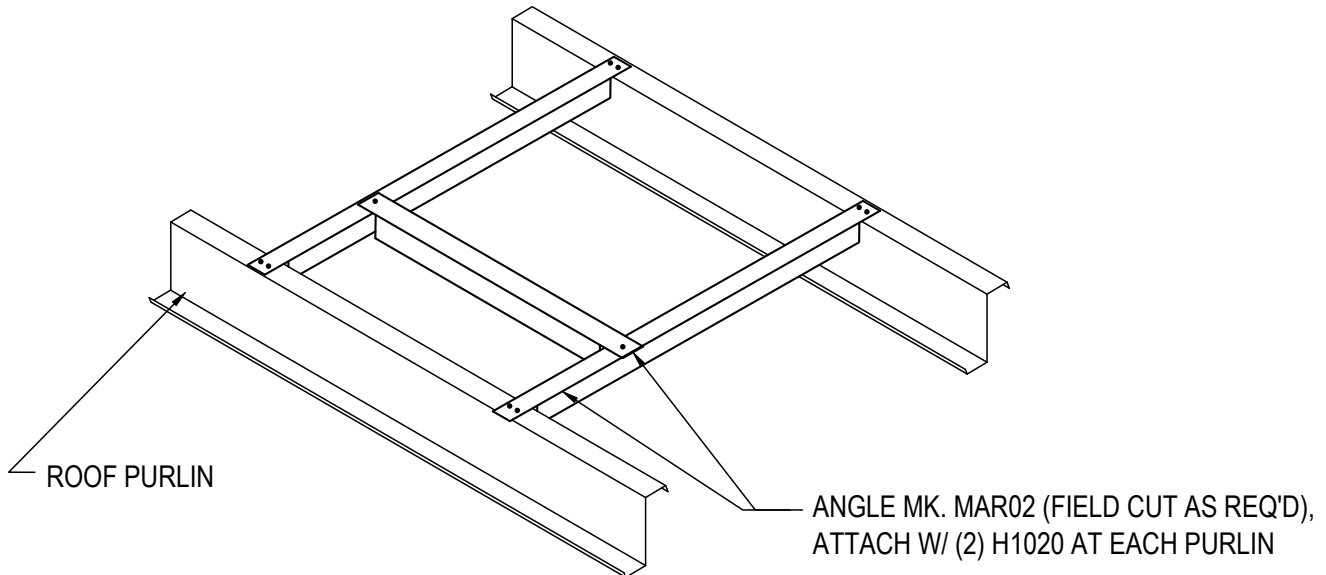

ALT. TRANSLUCENT PANEL SUPPORT DETAIL

R-PANEL ROOF AT NON-STANDARD PURLIN SPACING

DM0001

Detailer Notes:

1) N/A

DM0015 - TRANSLUCENT PANEL GENERAL NOTES

[Download the DWG file by clicking here.](#)

GENERAL NOTES ON PLACEMENT AND USE OF R-PANEL ROOF TRANSLUCENT PANELS

- 1) END TO END, TRANSLUCENT PANELS SHOULD BE SPACED SO THAT THE METALS PANELS ABOVE, BETWEEN AND BELOW ARE RESTING ON A MINIMUM OF (3) PURLINS, PREFERABLY (4). NO SIMPLE-SPAN ROOF PANEL CONDITIONS ARE ALLOWED. TRANSLUCENT PANELS SHALL NOT BE PLACED END TO END.
- 2) SIDE TO SIDE, TRANSLUCENT PANELS SHOULD HAVE A MINIMUM OF (4) METAL PANELS BETWEEN TRANSLUCENT PANEL LOCATIONS. TRANSLUCENT PANELS SHALL NOT BE PLACED SIDE BY SIDE.
- 3) TRANSLUCENT PANELS SHALL NOT BE PLACED FROM EAVE TO EAVE.
- 4) TRANSLUCENT PANELS SHALL NOT BE PLACED AT THE LOW EAVE OF THE BUILDING.
- 5) BUILDINGS WITH LESS THAN A 60'-0" PANEL RUN CAN TYPICALLY ONLY HAVE (1) TRANSLUCENT PANEL PER RUN.
- 6) THE LOCATION OF THE FIRST TRANSLUCENT PANEL UP FROM THE LOW EAVE SHOULD BE SET SO THAT THE LOW EAVE METAL PANEL IS SUPPORTED BY (4) PURLINS (OR APPROXIMATELY 15 FEET).
- 7) POLAR WHITE COLORED FASTENERS ARE SUPPLIED WITH TRANSLUCENT PANELS FOR USE WHERE THE TRANSLUCENT PANEL IS THE "EXPOSED" MATERIAL IN THE DETAIL.
- 8) PANEL RUNS WITH TRANSLUCENT PANELS HAVE BEEN PLACED ACCORDING TO THE AMOUNT ORDERED. PANEL RUNS WITH TRANSLUCENT PANELS CAN BE "EXCHANGED" WITH SIMILAR PANEL RUNS ACROSS THE LENGTH OF THE BUILDING TO BETTER SUIT THE BUILDING'S REQUIREMENTS.
- 9) THE 5'-4" TRANSLUCENT PANELS ARE TO BE USED STRICTLY IN VERTICAL WALL APPLICATIONS. THIS PANEL IS NOT TO BE INSTALLED IN A ROOF APPLICATION WHERE FALL HAZARDS COULD OCCUR. MBS ASSUMES NO RESPONSIBILITY FOR THE MISUSE OF THIS PANEL.

DM0015

Detailer Notes:

- 1) N/A

DM0020 - UNINSULATED (NON-UL90)

[Download the DWG file by clicking here.](#)

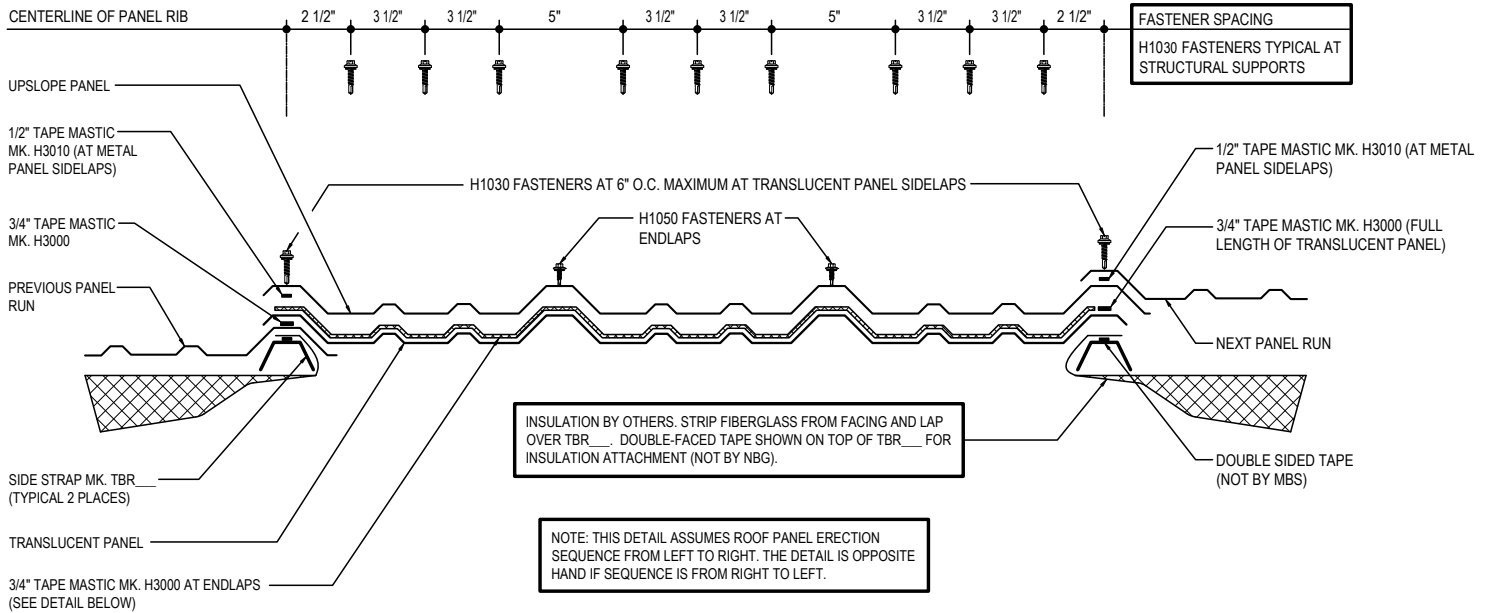

FASTENER SPACING AND MATERIALS PLACEMENT DETAIL

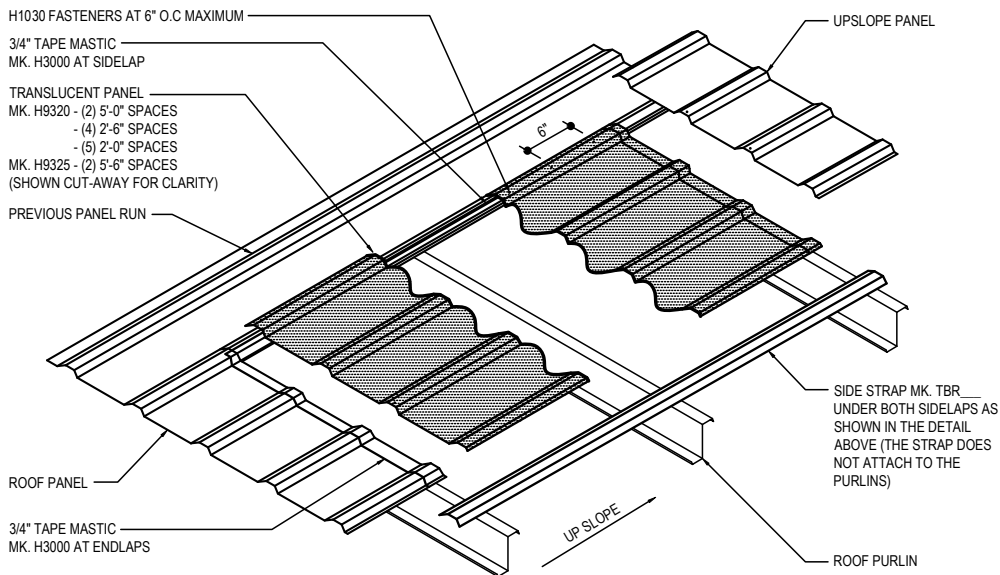

UNINSULATED TRANSLUCENT PANEL DETAIL

R-PANEL ROOF

ERECTOR NOTES

1. ERECT TRANSLUCENT PANEL IN THE SAME SEQUENCE AS A METAL PANEL (U.N.O.).
2. BE SURE TRANSLUCENT PANEL & MASTIC ARE FREE OF DUST & DEBRIS BEFORE INSTALLATION.
3. FASTENERS MUST PENETRATE THE MASTIC.
4. SEE "R-PANEL ROOF ERECTION NOTES" DETAIL FOR METAL PANEL INSTALLATION.
5. NEVER STEP, STAND OR APPLY WEIGHT TO TRANSLUCENT PANELS.

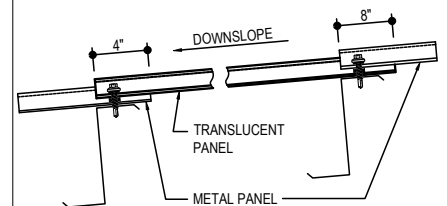

LAP DIMENSIONS

DM0020

Detailer Notes:

- 1) N/A

DM0022 - INSULATED (NON-UL90)

Download the DWG file by clicking [here](#).

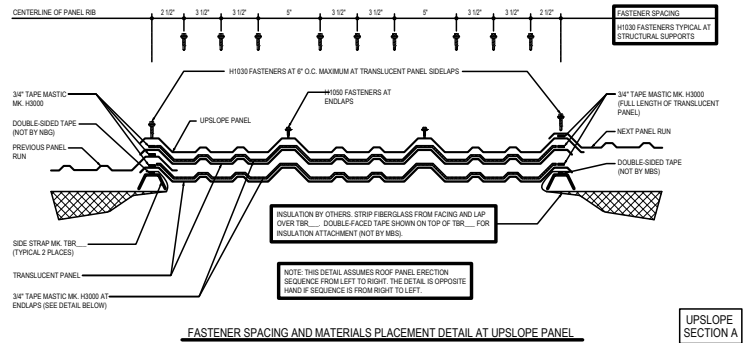

FASTENER SPACING AND MATERIALS PLACEMENT DETAIL AT UPSLOPE PANEL
UPSLOPE SECTION A

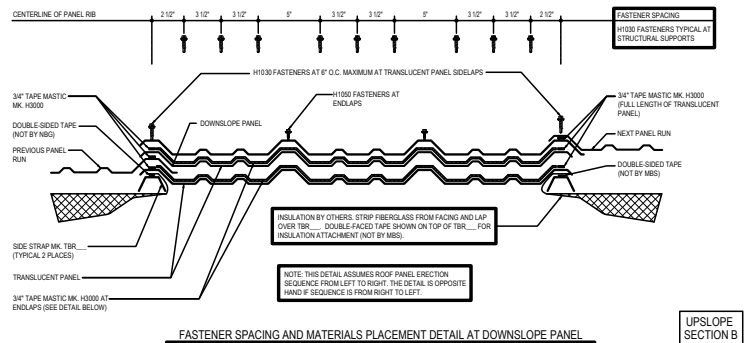

FASTENER SPACING AND MATERIALS PLACEMENT DETAIL AT DOWNSLOPE PANEL
UPSLOPE SECTION B

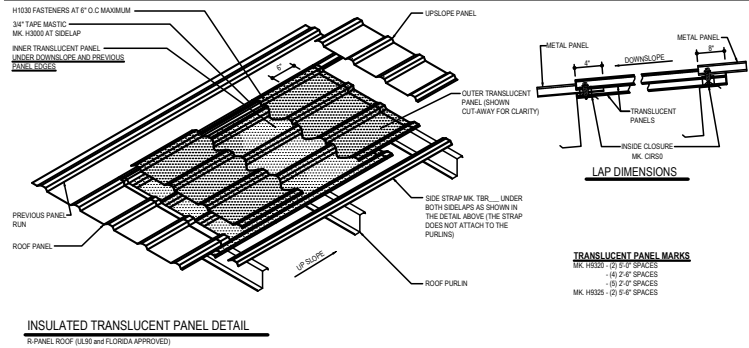

INSULATED TRANSLUCENT PANEL DETAIL
R PANEL ROOF (UL90 and FLORIDA APPROVED)

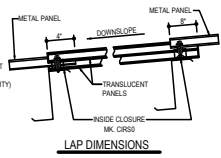

LAP DIMENSIONS

TRANSLUCENT PANEL MARKS
TR H1030 - (2) 3\"/>

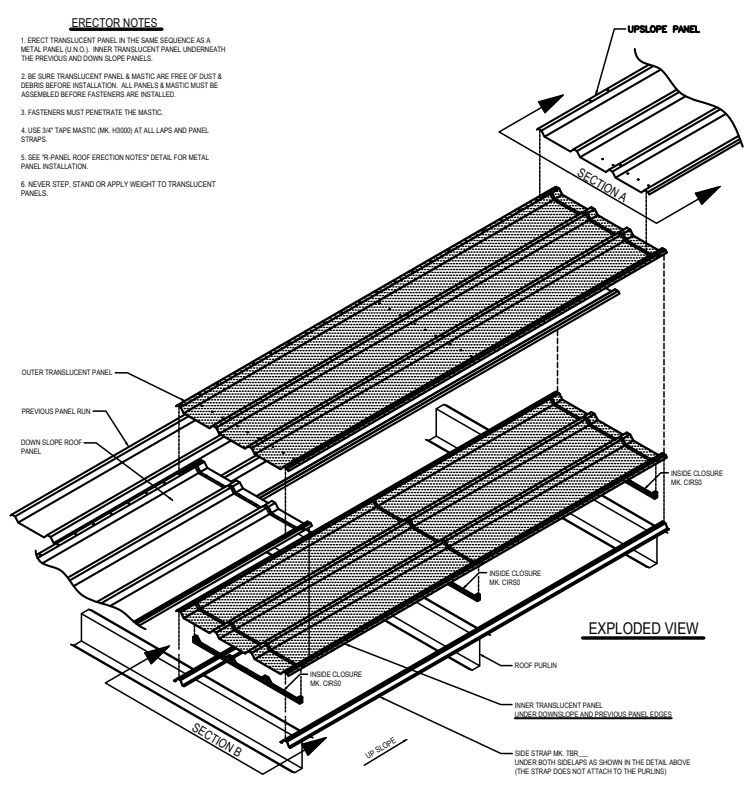

EXPLODED VIEW

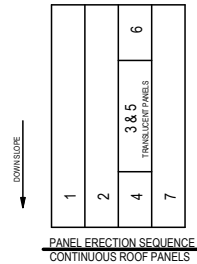

**PANEL ERECTION SEQUENCE
CONTINUOUS ROOF PANELS**

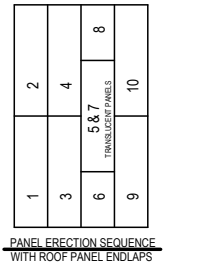

**PANEL ERECTION SEQUENCE
WITH ROOF PANEL ENDLAPS**

ERECTOR NOTES

1. ERECT TRANSLUCENT PANEL IN THE SAME SEQUENCE AS A METAL PANEL (S.I.D.). INNER TRANSLUCENT PANEL UNDERNEATH THE PREVIOUS AND DOWN SLOPE PANELS.
2. BE SURE TRANSLUCENT PANEL & MASTIC ARE FREE OF DUST & DEBRIS BEFORE INSTALLATION. ALL PANELS & MASTIC MUST BE ASSEMBLED BEFORE FASTENERS ARE INSTALLED.
3. FASTENERS MUST PENETRATE THE MASTIC.
4. USE 3/4\"/>

DM0022

Detailer Notes:

- 1) THIS DETAIL IS FOR FIELD ASSEMBLED INSULATED TRANSLUCENTS.

DM0023 - INSULATED (UL90 & FLORIDA APPROVED)

Download the DWG file by clicking [here](#).

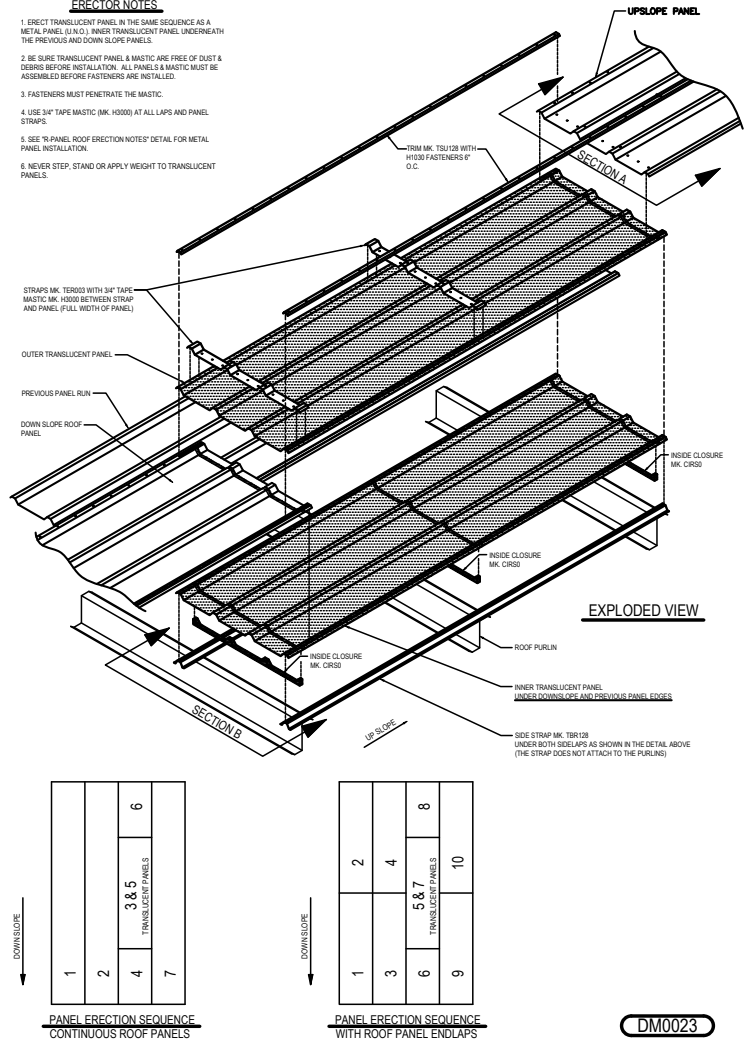
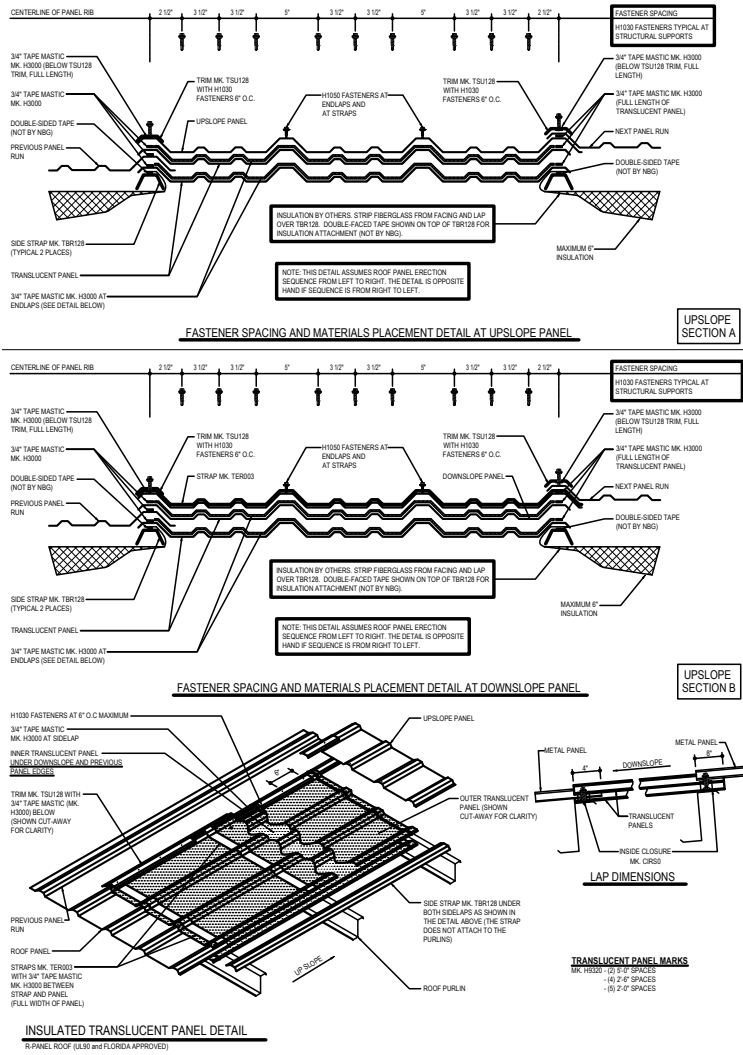

Detailer Notes:

- 1) THIS DETAIL IS FOR FIELD ASSEMBLED INSULATED TRANSLUCENTS.

DM0024 - FACTORY BONDED (NON-UL90)

[Download the DWG file by clicking here.](#)

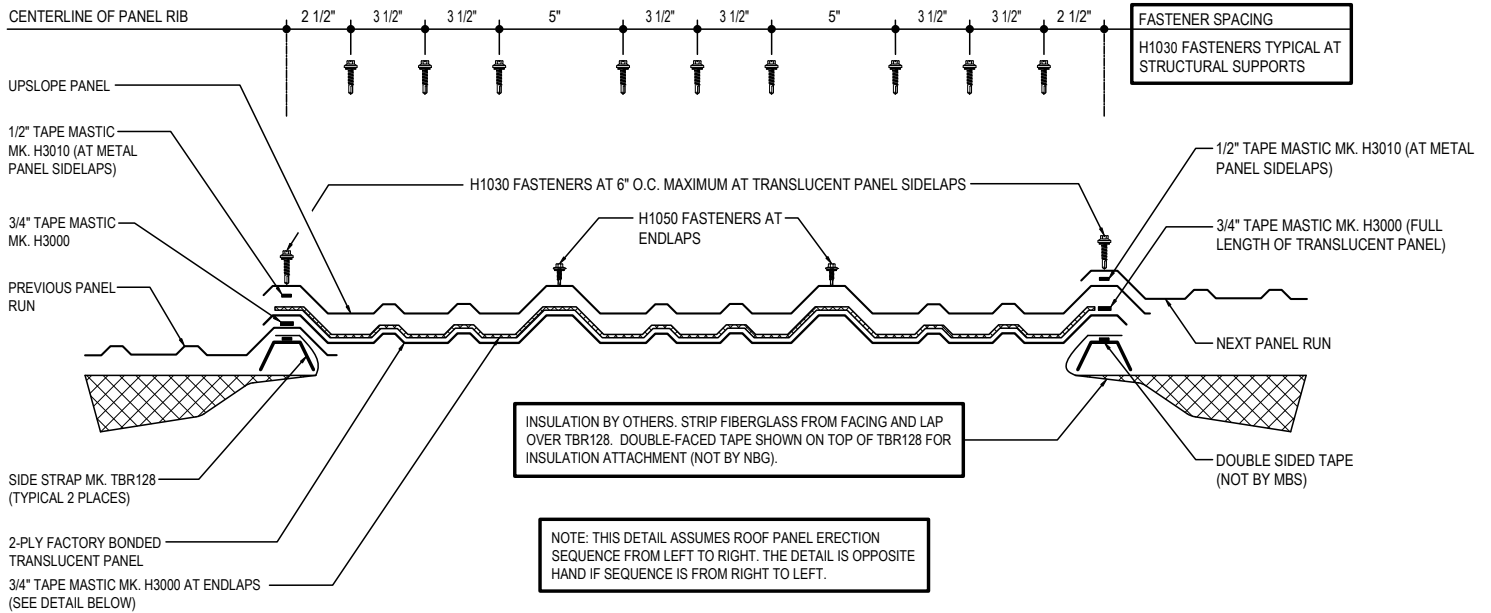

FASTENER SPACING AND MATERIALS PLACEMENT DETAIL

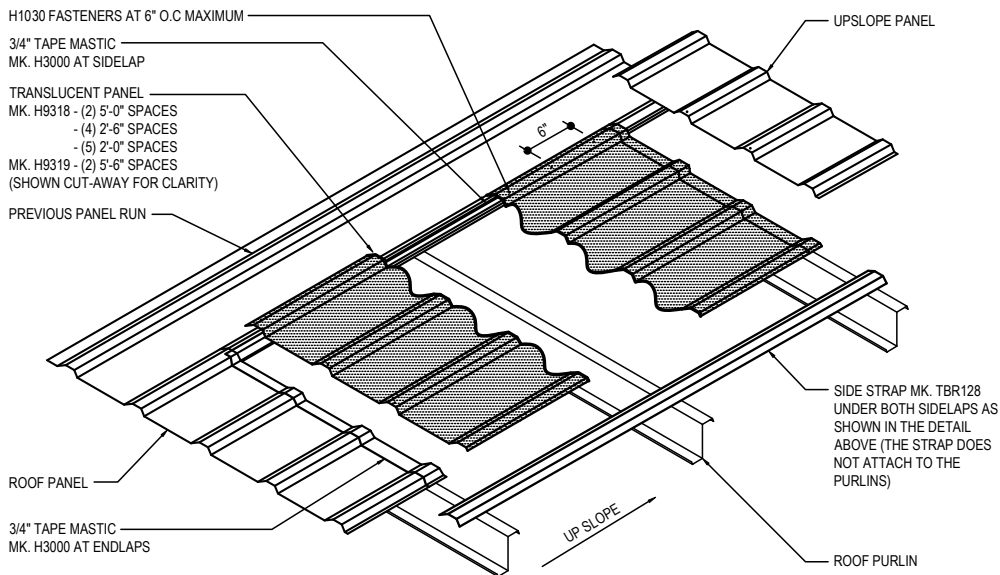

FACTORY BONDED INSULATED TRANSLUCENT PANEL DETAIL

R-PANEL ROOF

ERECTOR NOTES

1. ERECT TRANSLUCENT PANEL IN THE SAME SEQUENCE AS A METAL PANEL (U.N.O.).
2. BE SURE TRANSLUCENT PANEL & MASTIC ARE FREE OF DUST & DEBRIS BEFORE INSTALLATION.
3. FASTENERS MUST PENETRATE THE MASTIC.
4. SEE "R-PANEL ROOF ERECTION NOTES" DETAIL FOR METAL PANEL INSTALLATION.
5. NEVER STEP, STAND OR APPLY WEIGHT TO TRANSLUCENT PANELS.

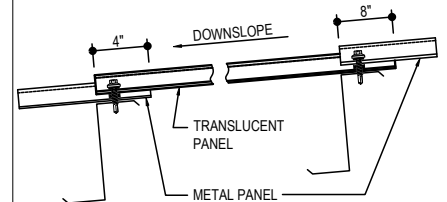

LAP DIMENSIONS

DM0024

Detailer Notes:

- 1) THIS DETAIL IS FOR FACTORY BONDED INSULATED TRANSLUCENT PANELS.

DM0025 - FACTORY BONDED (UL90 & FLORIDA APPROVED)

[Download the DWG file by clicking here.](#)

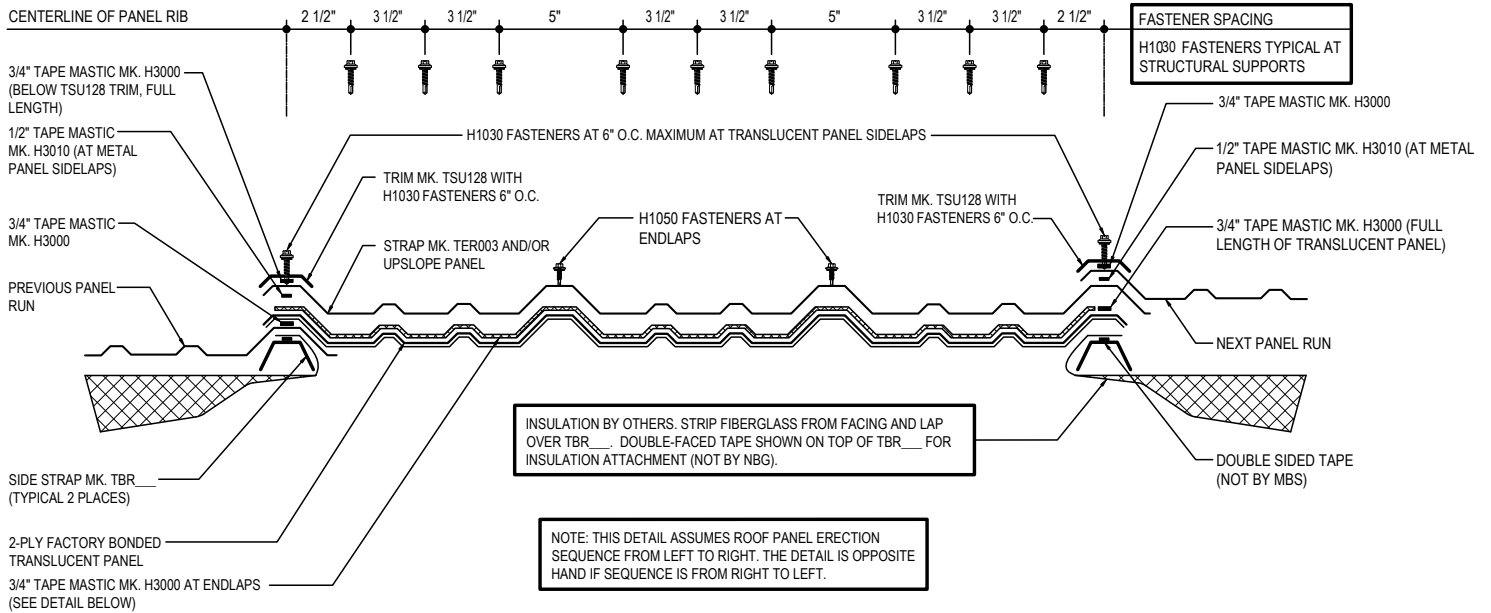

FASTENER SPACING AND MATERIALS PLACEMENT DETAIL

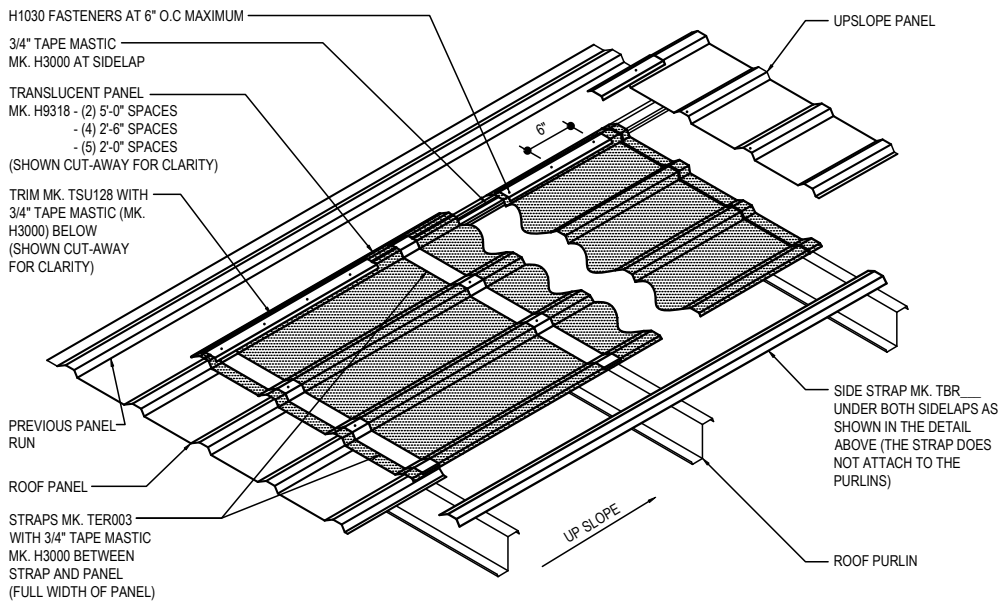

FACTORY BONDED INSULATED TRANSLUCENT PANEL DETAIL

R-PANEL ROOF (UL90 and FLORIDA APPROVED)

ERECTOR NOTES

1. ERECT TRANSLUCENT PANEL IN THE SAME SEQUENCE AS A METAL PANEL (U.N.O.).
2. BE SURE TRANSLUCENT PANEL & MASTIC ARE FREE OF DUST & DEBRIS BEFORE INSTALLATION.
3. FASTENERS MUST PENETRATE THE MASTIC.
4. SEE "R-PANEL ROOF ERECTION NOTES" DETAIL FOR METAL PANEL INSTALLATION.
5. NEVER STEP, STAND OR APPLY WEIGHT TO TRANSLUCENT PANELS.

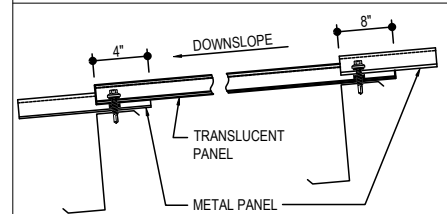

LAP DIMENSIONS

DM0025

Detailer Notes:

- 1) THIS DETAIL IS FOR FACTORY BONDED INSULATED TRANSLUCENT PANELS.

DM0026 - UNINSULATED (UL90 & FLORIDA APPROVED)

[Download the DWG file by clicking here.](#)

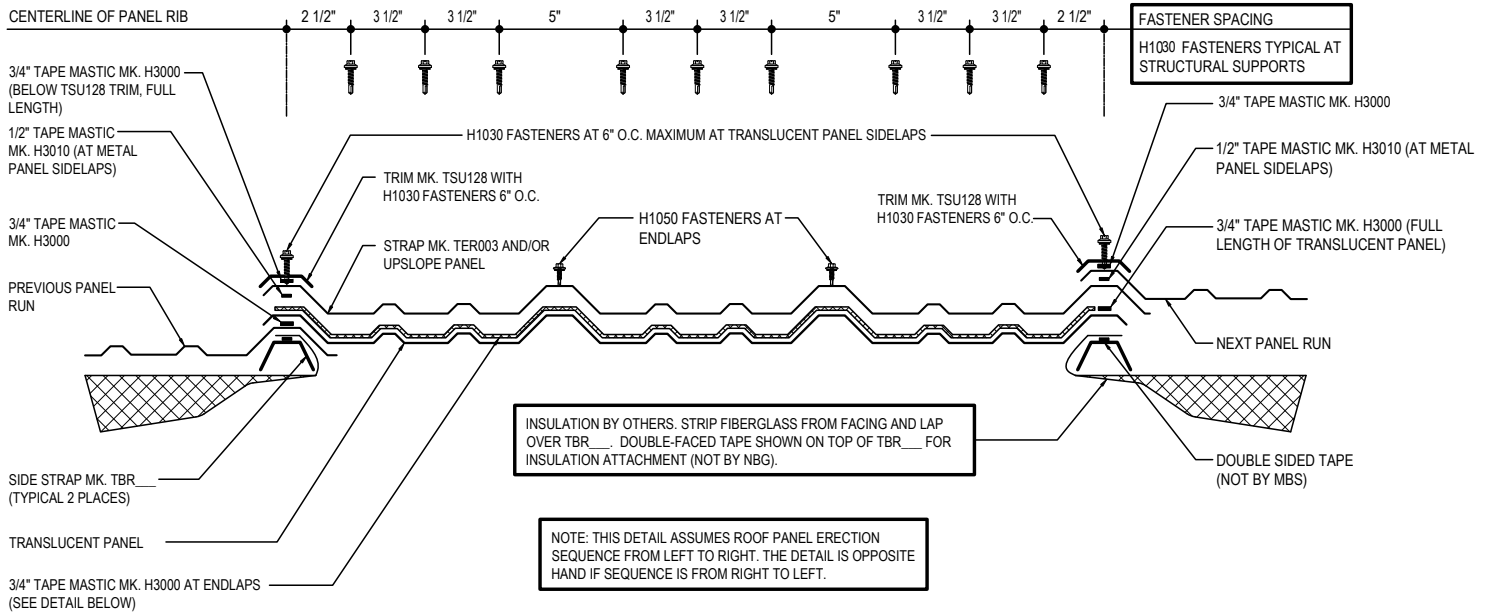

FASTENER SPACING AND MATERIALS PLACEMENT DETAIL

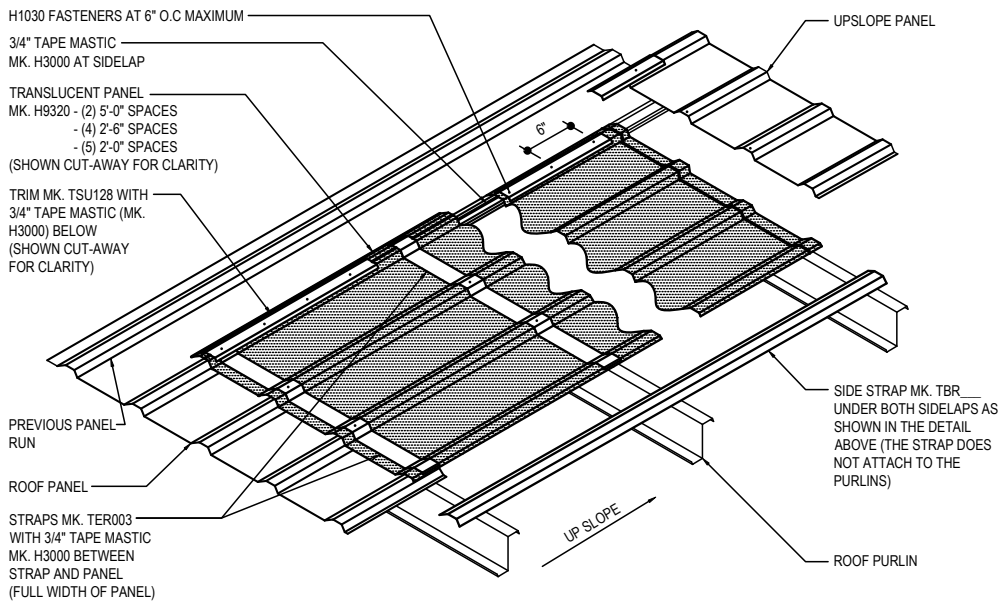

UNINSULATED TRANSLUCENT PANEL DETAIL

R-PANEL ROOF (UL90 and FLORIDA APPROVED)

ERECTOR NOTES

1. ERECT TRANSLUCENT PANEL IN THE SAME SEQUENCE AS A METAL PANEL (U.N.O.).
2. BE SURE TRANSLUCENT PANEL & MASTIC ARE FREE OF DUST & DEBRIS BEFORE INSTALLATION.
3. FASTENERS MUST PENETRATE THE MASTIC.
4. SEE "R-PANEL ROOF ERECTION NOTES" DETAIL FOR METAL PANEL INSTALLATION.
5. NEVER STEP, STAND OR APPLY WEIGHT TO TRANSLUCENT PANELS.

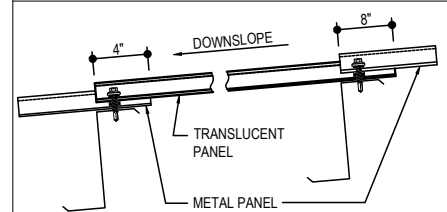

LAP DIMENSIONS

DM0026

Detailer Notes:

- 1) N/A